



WJW-SQ30-10



WJW-SQD30-10



WJW-SD30-10

◆ 특징(Features)

- 고회도 LED 점등/점멸형 조절 가능
Product of high-brightness, flashing LED type.
- 내부스위치 및 볼륨으로 음색, 음량 조절 가능.
It can control timble and sound volume with internal switch and volume.
- 알루미늄 하우징 선박, 중부하 제품으로 선박, 철강, 옥외플랜트 등 설치 가능.
Aluminum housing ship and heavy loading product that can set up vessel, steel and outdoor plant.
- 경고등과 혼이 일체형구조로 제작된 자립형 신호음 내장 제품
A warning light and horn is assembled and built in self-standing signal tone product.
- 방수, 방진(IP65)내식성 제품으로 옥외 설치 가능
It is water proof and vibration proof(IP65) corrosion resistance product so it is available outdoor set up.
- 외부 접촉으로부터 글로브를 보호하는 보호망 장착
Installed protection cage for preventing lens from outside impacting.

◆ 음색선택방법

(Method of selecting sound tone)

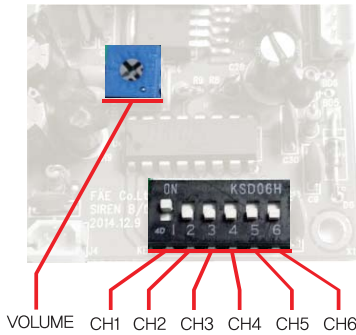

◆ 광원조정방법

(Light source control method)

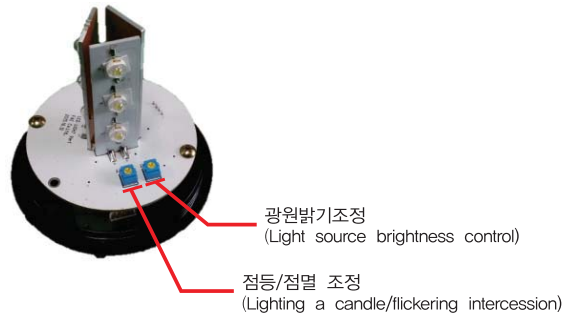

◆ 결선방법

(Wiring method)

내부 스위치를 이용하여 음색을 선택합니다.
Sound tone can be selected by internal switch

- Ch1 : 긴급 (Urgency)
- Ch2 : 보안 (Security)
- Ch3 : 경보1 (Alarm1)
- Ch4 : 경보2 (Alarm2)
- Ch5 : 경보3 (Alarm3)
- Ch6 : 구급 (First aid)

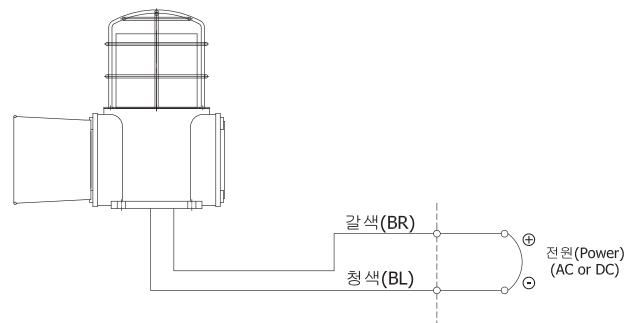

◆ 제품선정(Product selection)

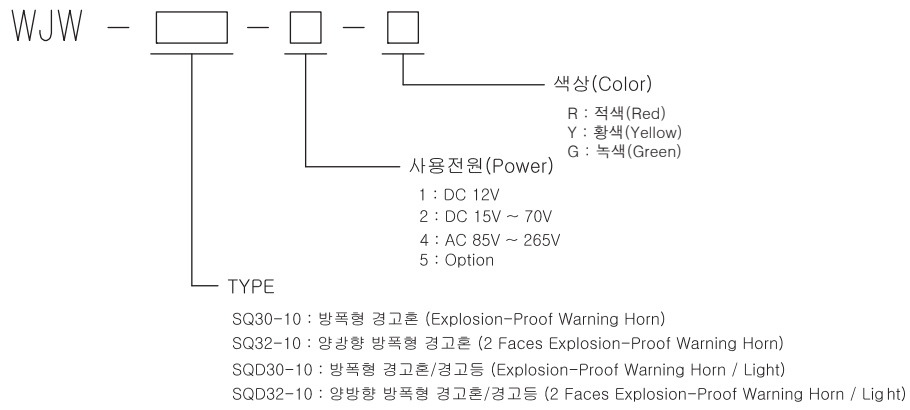

◆ 외형도(Outline Dimension)

WJW-SD30-10

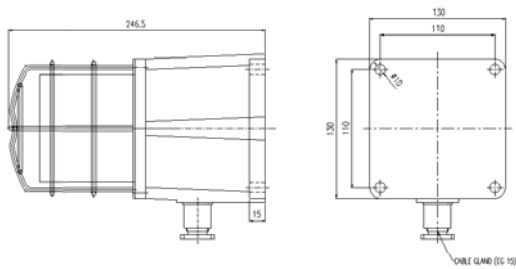

WJW-SQ30-10

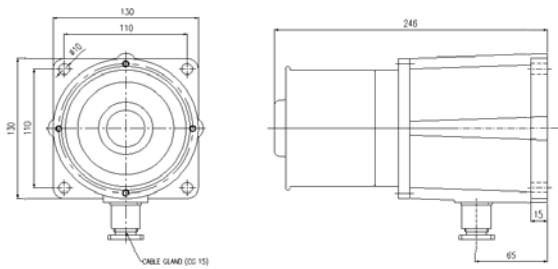

WJW-SQD30-10

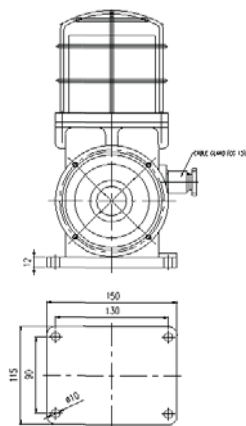

WJW-SQD32-10

